

QUAD DIFFERENTIAL COMPARATOR

DESCRIPTION

The UTC339 consists of four independent voltage comparators designed specifically to operate from a single power supply over a wide voltage range.

FEATURES

- *Single or dual supply operation
- *Wide operating supply range($V_{cc}=2V\sim 36V$)
- *Input common-mode voltage includes ground
- *Low supply current drain $I_{CC}=0.8mA$ (Typical)
- *Open collector outputs for wired and connection
- *Low input bias current $I_{bias}=25nA$ (Typical)
- *Low output saturation voltage
- *Output compatible with TTL ,DTL, and CMOS logic system

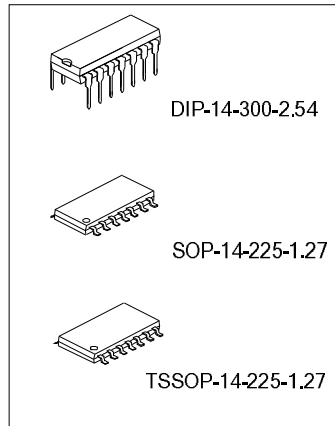

ORDERING INFORMATION

Device	Package
UTC339	DIP-14-300-2.54
UTC339E	SOP-14-225-1.27
UTC339V	TSSOP-14-225-0.65

ABSOLUTE MAXIMUM RATINGS($T_a=25^{\circ}C$)

Characteristic	Symbol	Value	Unit
Supply Voltage	V_{cc}	± 18 OR 36	V
Differential input voltage	V_{IDiff}	36	V
Input Voltage	V_I	-0.3~36V	V
Power Dissipation	P_d	570	mW
Operating Temperature	T_{opr}	0 to +70	$^{\circ}C$
Storage Temperature	T_{stg}	-65 to 150	$^{\circ}C$

ELECTRICAL CHARACTERISTICS

(Vcc=5.0V, Ta=25°C, All voltage referenced to GND unless otherwise specified)

Characteristic	Symbol	Test Condition	Min	Typ.	Max	Unit
Input offset voltage	V _{io}	V _{CM} =0 to V _{CC} -1.5 V _{o(p)} =1.4V, R _s =0		±1.5	±5.0	mV
Input offset current	I _{IO}			±2.3	±50	nA
Input Bias current	I _b			57	250	nA
Input Common-mode voltage range	V _{I(R)}		0		V _{CC} -1.5	V
Supply Current	I _{CC}	R _L =∞		1.1	2.0	mA
Large signal Voltage Gain	G _v	V _{CC} =15V, R _L >15kΩ	50	200		V/mV
Large signal response time	t _{res}	V _i =TTL logic wing V _{ref} =1.4V, V _{RL} =5V, R _L =5.1kΩ		350		ns
Response time	t _{res}	V _{RL} =5V, R _L =5.1kΩ		1400		ns
Output sink current	I _{sink}	V _{i(-)} >1V, V _{i(+)} =0V, V _{o(p)} <1.5V	6	18		mA
Output saturation voltage	V _{sat}	V _{i(-)} >1V, V _{i(+)} =0V, I _{sink} =4mA	140	400		mV
output leakage current	I _{leakage}	V _{I(+)} =1V, V _{I(-)} =0	20	40		mA
Differential input voltage	V _{I(diff)}				36	V

BLOCK DIAGRAM

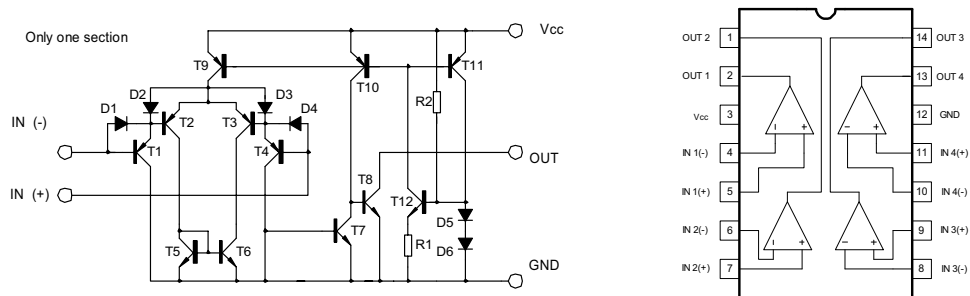

TYPICAL CHARACTERISTICS PERFORMANCE

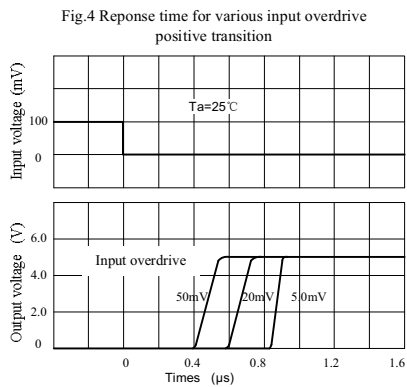
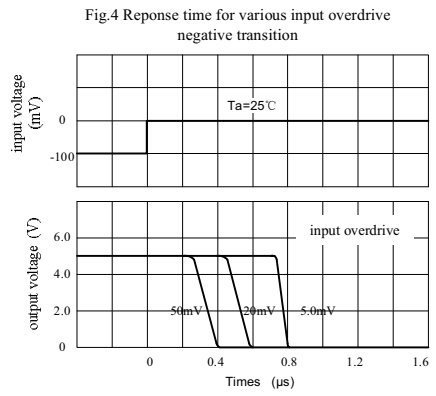
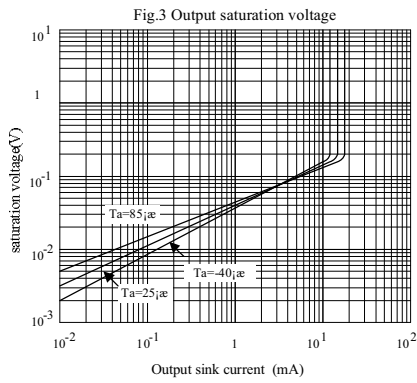
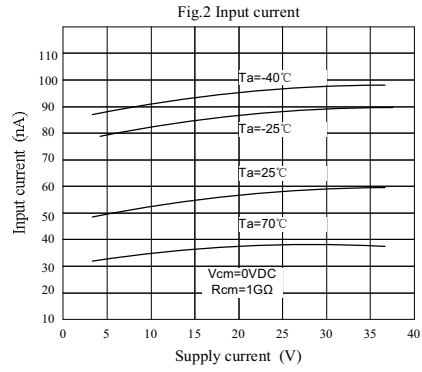
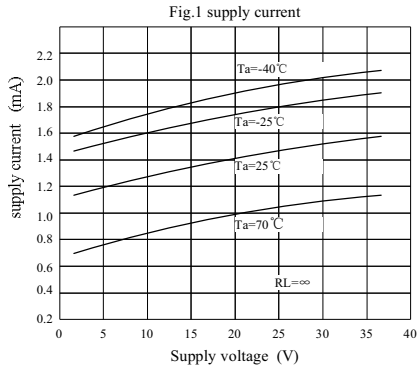

Fig.7

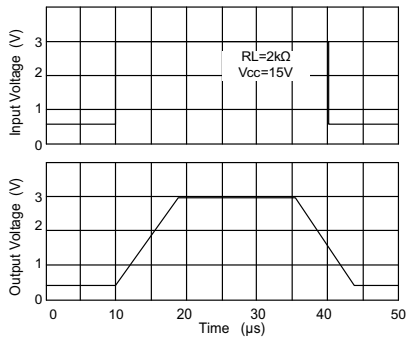

Fig.8 voltage Follower pulse response (small signal)

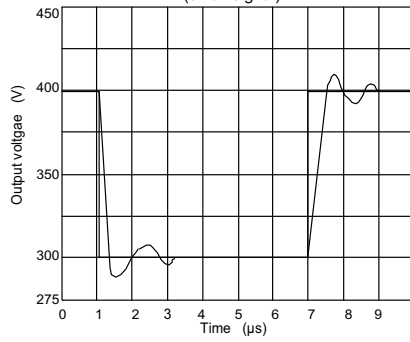

Fig.9 Large signal Frequency Response

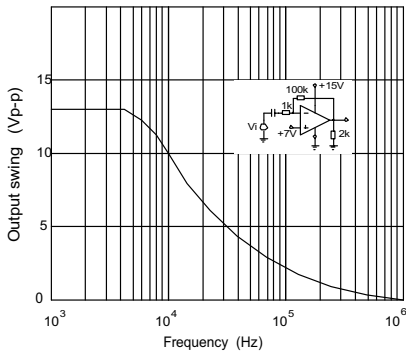

Fig.10 Output Characteristics current sourcing

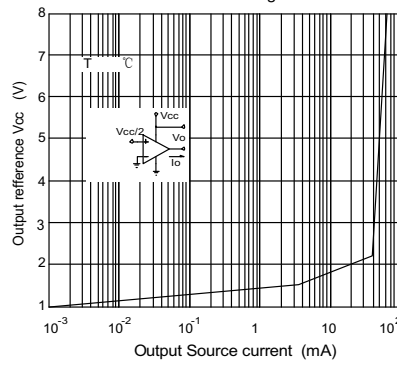

Fig.11 Output Characteristics Current sinking

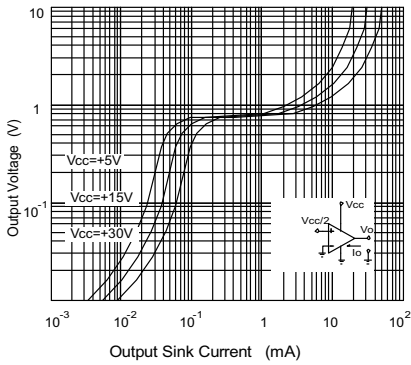
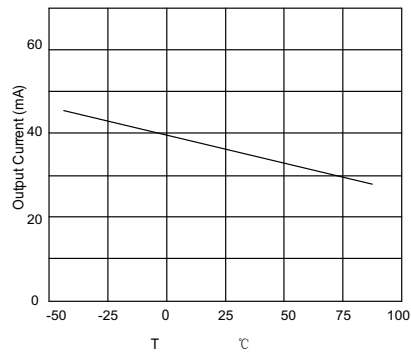
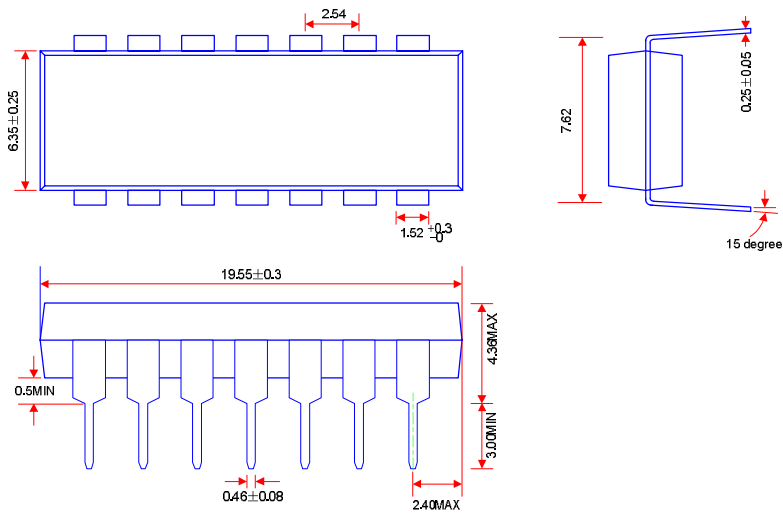

Fig.12 Current Limiting



PACKAGE OUTLINE

DIP-14-300-2.54 UNIT: mm



SOP-14-225-1.27 UNIT: mm

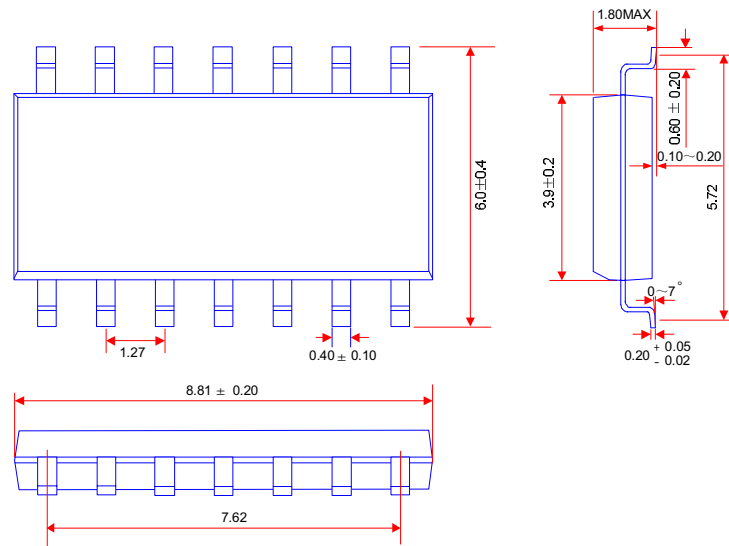

PACKAGE OUTLINE(CONTINUED)

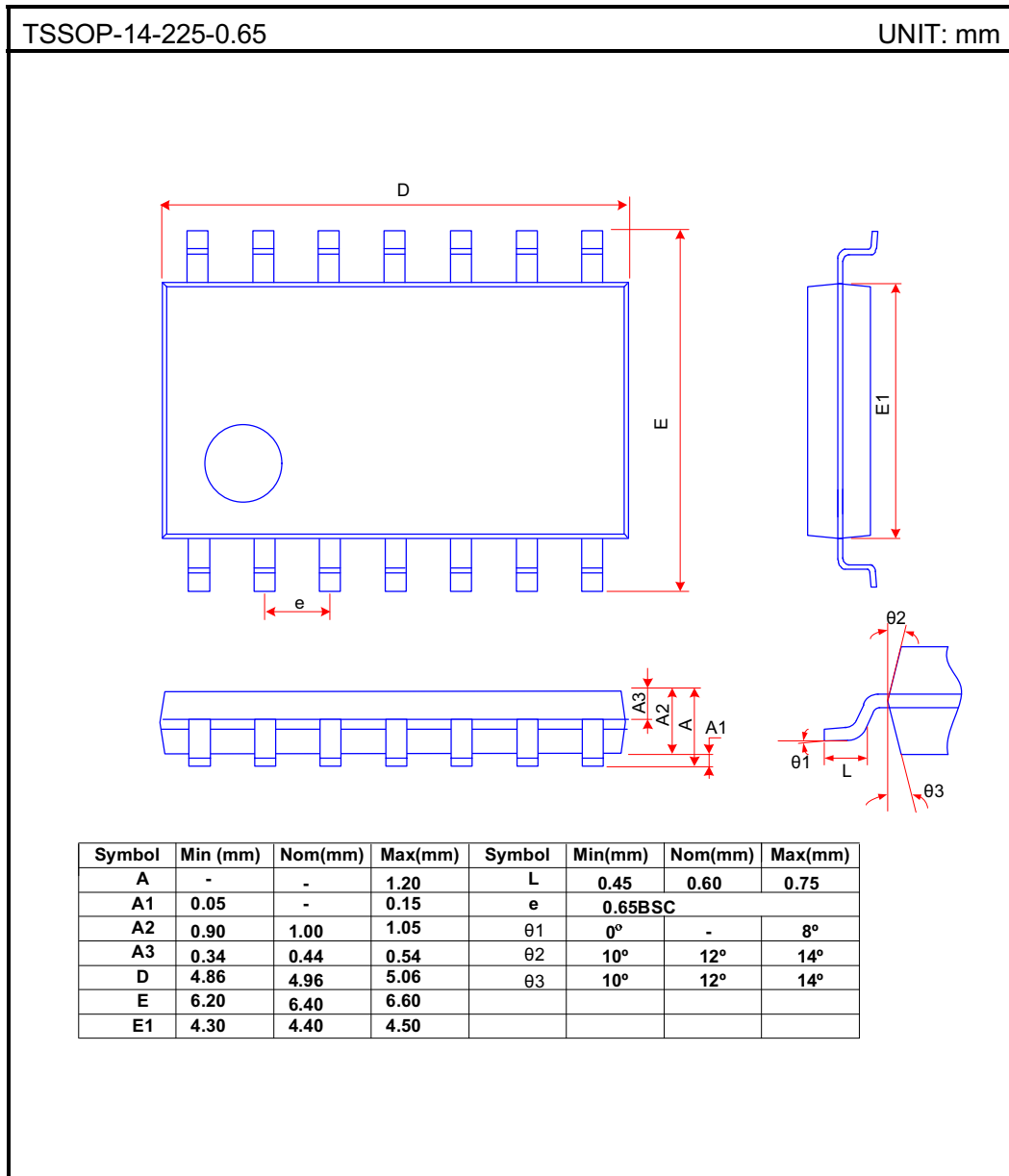

Attach

Revision History

Data	REV	Description	Page
	1.0	Original	
2005.12.01	1.1	Add "PACKAGE OUTLINE DIP-14,SOP-14"	5
2006.03.29	1.2	Add "PACKAGE OUTLINE TSSOP-14-225-0.65" Revise" Figure2"	6 3